

# COBY<sup>TM</sup>

# TF-DVD7307

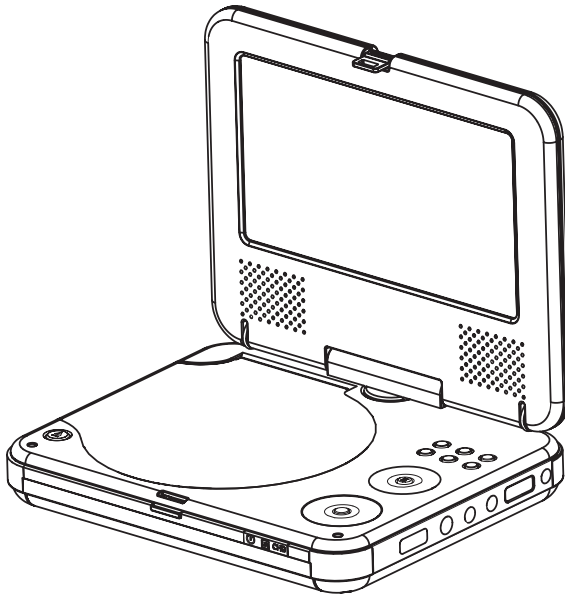

7" Wide Screen TFT LCD  
Portable DVD/CD/MP3 Player with Swivel Screen



## Instruction Manual

Please read this manual carefully before operation.

# SAFETY INSTRUCTIONS

	<b>CAUTION</b> RISK OF ELECTRIC SHOCK DO NOT OPEN	
<b>CAUTION:</b> TO REDUCE THE RISK OF FIRE AND ELECTRIC SHOCK, DO NOT REMOVE THE COVER (OR BACK) OF THE UNIT. REFER SERVICING ONLY TO QUALIFIED SERVICE PERSONNEL.		

## For Customer Use:

Enter below the serial number that is located on the bottom of the unit. Retain this information for future reference.

Model No. TF-DVD7307

Serial No. \_\_\_\_\_



The lightning flash with arrowhead symbol within an equilateral triangle is intended to alert the user to the presence of uninsulated "dangerous voltage" within the product's enclosure that may be of sufficient magnitude to constitute a risk of electric shock.



The exclamation point within an equilateral triangle is intended to alert the user to the presence of important operation and servicing instructions in the literature accompanying the appliance.

## WARNING:

To prevent fire or shock hazard, do not expose this device to rain or moisture. Dangerous high voltage is present inside the enclosure. Do not open the cabinet.

## CAUTION:

This Digital Video Disc player employs a laser system. To prevent direct exposure to the laser beam, do not try to open the enclosure or defeat the safety interlocks. When open and the interlocks are defeated, visible laser radiation is present.

Use of controls, adjustments, or performance of procedures other than those specified herein may result in hazardous radiation exposure. **DO NOT STARE INTO THE BEAM.**

## FCC Notice:

This equipment has been tested and found to comply with the limits for a Class B digital device pursuant with the FCC Rules, Part 15. These limits are designed to provide reasonable protection against harmful interference in a residential installation.

This equipment generates, uses, and can radiate radio frequency energy, and if not installed and used in accordance with the instructions may cause harmful interference to radio communication.

## WARNING:

Handling the cords on this product will expose you to lead, a chemical known to the State of California to cause cancer, and birth defects or other reproductive harm. **Wash hands after handling.**

## CAUTION:

To prevent electric shock, match wide blade of plug to wide slot of outlet and fully insert.

## NOTICE:

This product incorporates copyright protection technology that is protected by U.S. patents and other intellectual property rights. Use of this copyright protection technology must be authorized by Macrovision, and is intended for home and other limited viewing uses only unless otherwise authorized by Macrovision. Reverse engineering or disassembly is prohibited.



For recycling or disposal information about this product, please contact your local authorities or the Electronics Industries Alliance: [www.eiae.org](http://www.eiae.org).

# SAFETY INSTRUCTIONS

1. Read these instructions carefully. Keep these instructions for future reference.
2. Heed all warnings and follow all instructions.
3. Do not expose to water or moisture.
4. Clean only with a dry cloth.
5. Keep objects away from ventilation openings. Do not block ventilation openings at any time.
6. Do not install near any apparatus that produces heat such as stoves, radiators, amplifiers, etc.
7. Do not force the power plug into a wall outlet. If the plug provided does not fit into your outlet, consult an electrician for replacement of the obsolete outlet. (A polarized plug has two blades where one is wider than the other; the wide blade is provided for your safety.)
8. Do not place heavy objects on the power cord. Protect the cord from being walked on, pinched by objects, or torn and exposed to liquids (especially at plugs, convenience receptacles, and the point at which they exit from the device).
9. Use only with attachments/accessories specified by the manufacturer. Use of attachments/accessories not recommended by the product manufacturer may be hazardous.
10. Unplug the device during lightning storms. Unplug the device and remove any batteries when the device will be unused for long periods of time.
11. Do not use this device near water. Do not place objects filled with liquids (eg, vases) on the device. Never spill liquid of any kind on the device.
12. Never push objects of any kind into this device through openings as they may touch dangerous voltage points or short out parts that could result in a fire or electric shock.
13. Do not use headphones/earphones while cycling, driving, or operating a motorized vehicle.
14. Do not use headphones/earphones at high volume.
15. Do not drop or otherwise subject the device to impact.
16. Do not open or attempt to repair this device. Refer all repairs to authorized service personnel.
17. When replacements parts are required, be sure the service technician has used replacement parts specified by the manufacturer or that have the same characteristics as the original part. Unauthorized substitutions may result in fire, electric shock, or other hazards.
18. Upon completion of any service or repairs to this device, ask the service technician to perform safety checks to determine that the device is in proper operating condition.

**Note:**

*The main plug is used to disconnect the device. It should remain within reach and should not be obstructed during intended use.*

*The rating label is located on the bottom enclosure of the device.*

# TABLE OF CONTENTS

SAFETY INSTRUCTIONS .....	2
TABLE OF CONTENTS .....	4
ABOUT OPTICAL DISCS .....	6
Disc Requirements .....	6
Disc Care and Maintenance .....	6
Handling a Disc .....	6
Cleaning a Disc .....	6
PACKAGE CONTENTS .....	7
LOCATION OF CONTROLS .....	8
Main Unit .....	8
Remote Control .....	9
CONNECTIONS .....	10
Audio/Video (AV) Connections .....	10
AV OUT .....	10
AV IN .....	10
Dolby Pro Logic Surround (Optical Audio) Connection .....	11
Remote Control .....	12
Power Supply .....	12
Using the AC/DC Adapter .....	12
Using the Battery Pack (DC) .....	13
BASIC OPERATIONS .....	14
Basic Playback .....	14
Play/Pause/Stop .....	14
Forward/Back (Skip) .....	14
Fast-Forward/Fast-Reverse (Search) .....	14
Slow .....	14
Menu Navigation .....	15
Numeric Keypad .....	15
Adjusting the Volume .....	15
Disc Error Messages .....	15
Power Management .....	15
FUNCTION BUTTONS .....	16
LCD Mode .....	16
Display .....	16
Menu / Title / Return .....	16
Setup .....	16
MORE FUNCTIONS .....	17
Search .....	17
DVD Chapter/Title Search: .....	17
DVD Time Search (within a specified title): .....	17
CD Time Search: .....	17



# TABLE OF CONTENTS

Repeat Mode.....	17
Repeat A-B Mode .....	17
Multi-Angle/Subtitle/Audio .....	18
Zoom .....	18
Program .....	18
<b>DVD Program Mode .....</b>	<b>18</b>
CD Program Mode .....	19
MP3 Program Mode.....	19
SETUP .....	20
Language Setup.....	20
Screen Setup .....	20
Audio Setup.....	21
Custom Setup .....	21
SPECIFICATIONS.....	22
TROUBLESHOOTING .....	23

# ABOUT OPTICAL DISCS

## Disc Requirements

This DVD player supports playback of the following discs.

Type	Disc Mark	Content Type	Disc Size	Max. Playback Time
DVD-Video Discs		Audio + Video (moving picture)	12 cm	133 min (SS-SL)
				242 min (SS-DL)
				266 min (DS-SL)
				484 min (DS-DL)
Audio Compact Discs (CDs)		Audio	12 cm	74 min
MP3 CDs	 (CD-R, CD-RW)	Audio	12 cm	~14 hours
JPEG CDs	--	Still Picture	12 cm	--

This unit can play back CD-R and CD-RW discs that contain audio titles, MP3 files, or JPEG picture files. Discs not listed above are not supported by this unit (eg, PC CD-ROM, CD-Extra, CD-G, CD-I, etc.)

## Disc Care and Maintenance

Optical discs (DVDs, CDs) contain high-density compressed data and need proper handling.

### **Handling a Disc**

- Hold a DVD/CD by its edges. Avoid touching the recorded side of the disc. To remove a DVD/CD from its storage case, press down on the center retention mechanism of the case and lift the disc out.
- Do not subject discs to prolonged exposure to direct sunlight, high humidity, or high temperatures.
- Do not bend or press discs.
- To reduce the risk of scratches, always put discs back in their case after use. Store discs vertically in a cabinet.
- Do not place stickers or labels on either side of a disc.



### **Cleaning a Disc**

Use a dry, soft cloth to wipe off any fingerprints and dusts from the playing surface of the disc. Wipe in a straight line radially from the center to the outside edge of the disc. Small dust particles and light stains will not affect playback quality.

- Never use chemicals such as record sprays, anti-static sprays, benzene, or thinners to clean a disc. Doing so will damage the surface of the disc permanently.

# PACKAGE CONTENTS

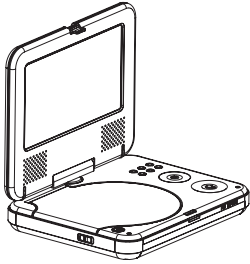

TF-DVD7307



Remote Control

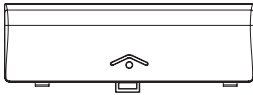

Rechargeable Battery Pack

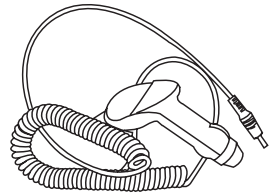

Car/Boat DC Power Adapter

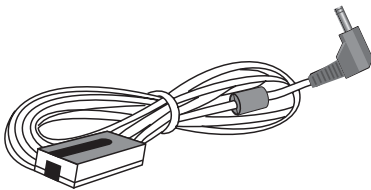

AC Power Adapter

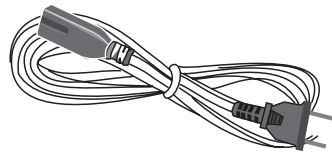

Power Cord

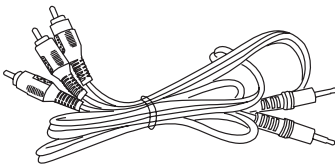

AV Cable (RCA)

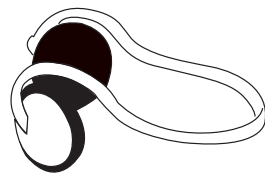

Headphones

# LOCATION OF CONTROLS

## Main Unit

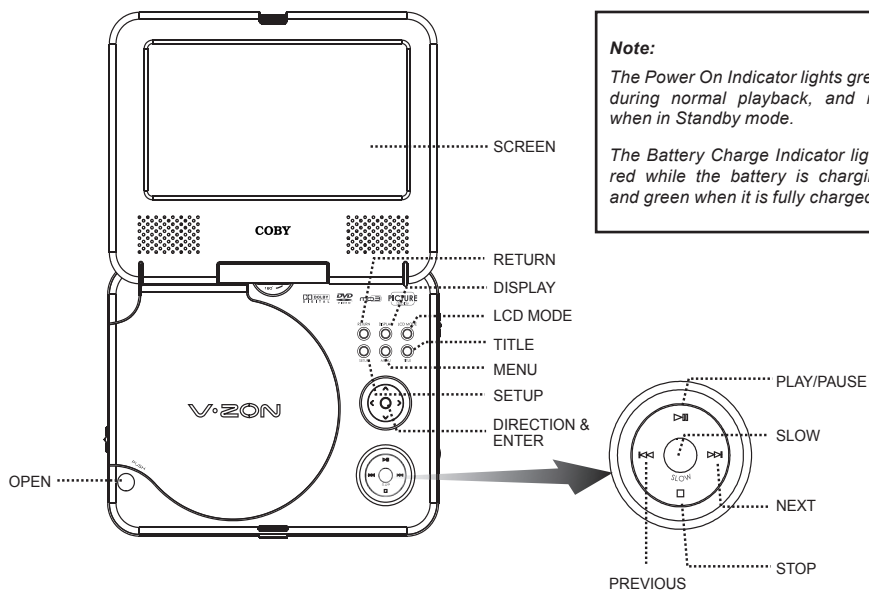
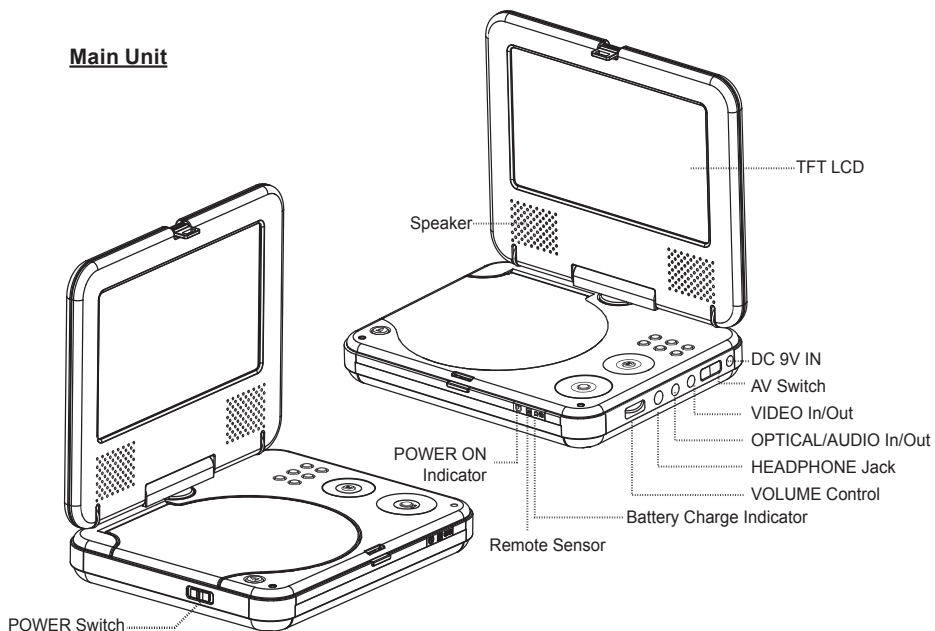

**Note:**

The Power On Indicator lights green during normal playback, and red when in Standby mode.

The Battery Charge Indicator lights red while the battery is charging, and green when it is fully charged.



# LOCATION OF CONTROLS

## Remote Control

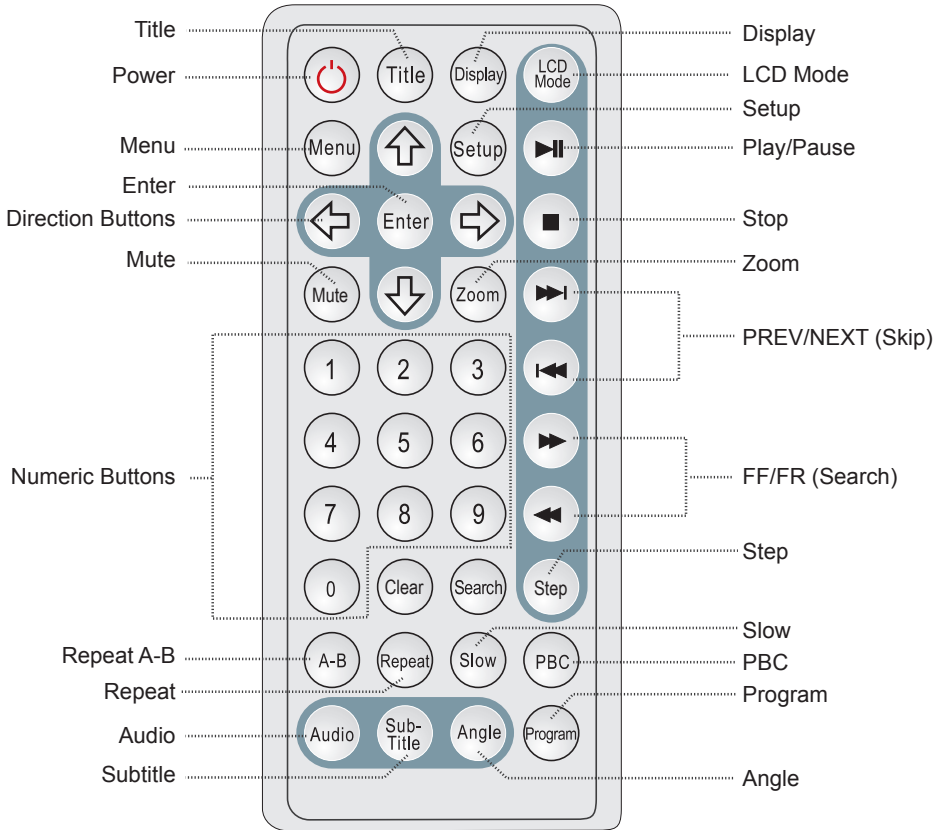

# CONNECTIONS

## Audio/Video (AV) Connections

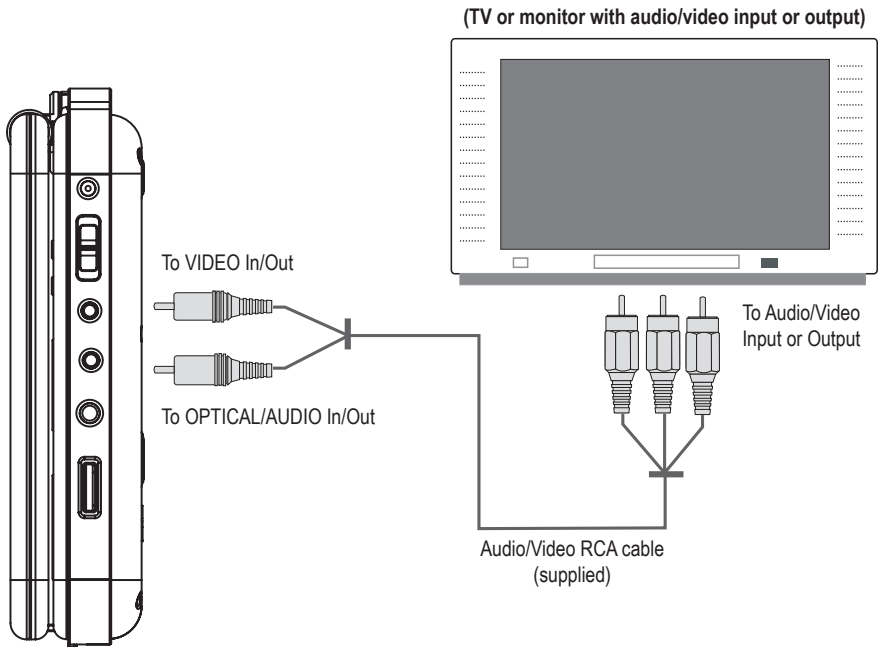

### **AV OUT**

1. Set the AV Switch to the AV OUT position.
2. Connect the player to a TV with the supplied AV Cable (RCA).
3. Press the AV mode button on your TV to display your player's output signal on the screen.

### **AV IN**

1. Set the AV Switch to the AV IN position.
2. Connect the player to an external audio/video device (eg, TV, Video Game, Portable Media Player, etc).

### **NOTE:**

- Refer to your TV's instruction manual for more information on setting it to the proper AV mode.
- Be sure to turn off and unplug your player and TV before making these connections.

# CONNECTIONS

## Dolby Pro Logic Surround (Optical Audio) Connection

Your player can output 5.1-channel surround sound audio through the Optical/Audio jack. You will need a Dolby Pro Logic Surround amplifier and an optical cable to use this feature.

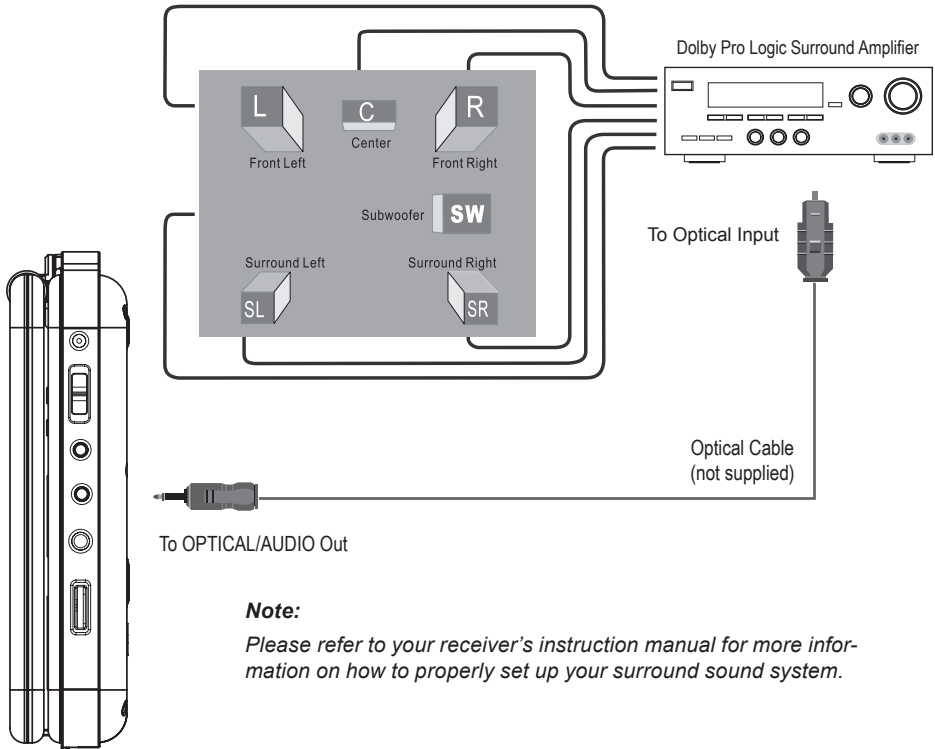

# GETTING STARTED

## Remote Control

- Refer to the diagram. Remove the battery compartment cover located on the rear of the remote control. Insert batteries, making sure to match their polarities (+/-) to the markings on the inside of the compartment. Replace the cover.
- To use the remote, point it at the remote sensor of the player. Operate the remote within 15 feet of the sensor and at an angle of +/- 60 degrees.
- Batteries in the remote will last for approximately 1 year. Replace the batteries if the remote control does not work. Do not mix old with new batteries, or different types of batteries.
- Remove the batteries from the remote if it will not be used for a long period of time.

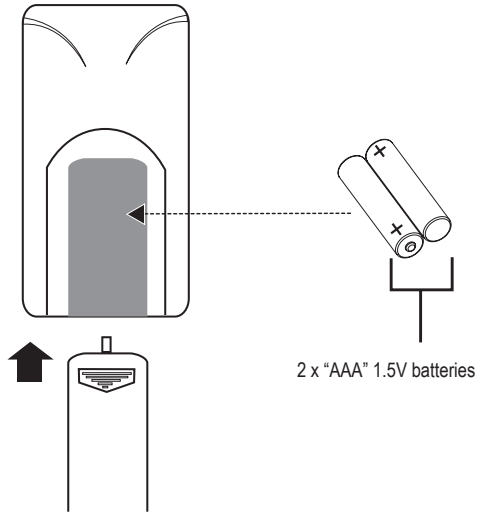

## WARNING

- The battery used in this device may present a fire or chemical burn if mistreated. Do not recharge, disassemble, incinerate, or heat the battery (~212°F).
- Keep batteries away from children.

## Power Supply

### Using the AC/DC Adapter

This AC/DC adapter should be used with 100-240V 50/60Hz AC wall outlets.

- DC Out: 9V
- DC Current: 2.0A min.

### Caution:

- *Do not connect the power plug to a power outlet other than that which is indicated here and on the label as this may result in the risk of fire or electric shock.*
- *Do not handle the power plug with wet hands. Doing so may cause electric shock.*
- *Only use AC adapters of the type specified here. Failure to do so may cause a fire or damage the player.*

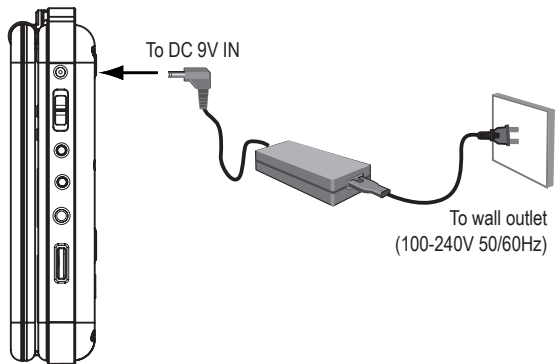

# GETTING STARTED

## Using the Battery Pack (DC)

The rechargeable battery pack can be used for approximately 300 charge-cycles without any noticeable change in performance.

**Important: The battery should be charged fully (minimum 4 hours) before its initial use to ensure optimum lifetime performance.**

To install the battery pack:

1. Place the battery into the recessed cradle located on the bottom of the player.
2. Insert the battery hooks into their slots and slide the battery into place. Slide the OPEN (release) button up to lock the battery in place.
3. To release the battery, slide the OPEN (release) button down in the direction of the arrow, and then slide the battery out.

To charge the battery pack:

1. Install the battery in the manner described above.
2. Connect the player to an AC power source with the AC/DC adapter as described above. (The Battery Charge indicator will light red while it is charging; it will light green when the battery is fully charged.)

### Note:

When the battery charge level is low, the unit will enter STANDBY mode automatically.

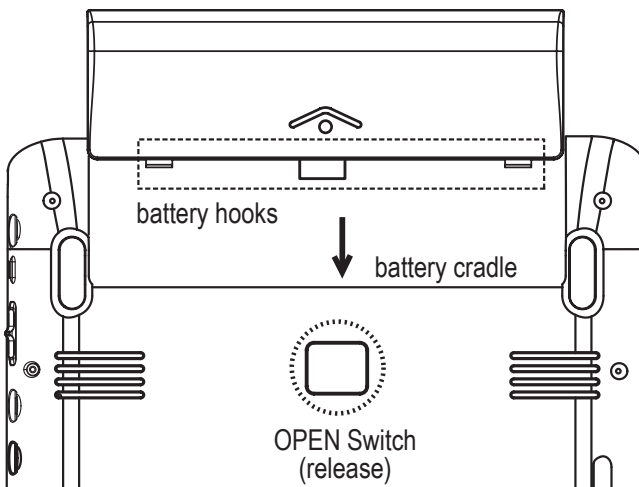







# BASIC OPERATIONS



## **Basic Playback**

1. Prepare the power supply.  
Set the Power Switch to the ON position to turn the player on.
2. Load a disc.  
Press the Open button to open the disc compartment lid. Insert a disc with the label-side up. Close the lid by hand (the lid will click into place).
  - If a single-sided disc is inserted upside-down, the player will display "NO DISC" or "BAD DISC".
3. Start playback.  
Make sure the AV Switch is set to AV OUT to use the player's built-in LCD screen. Press PLAY to start playback (some discs may start playing automatically).





## **Play/Pause/Stop**





- Press  to play the disc for the first time.
- Press  during playback to pause. Press  again to resume playback.
- Press  during playback to stop the disc ("Pre-Stop"). Press  to resume playback at the time-point at which the disc was stopped.
- Press  when the disc is "Pre-Stopped" to stop playback completely. (When  is pressed, the disc will start playing from the beginning.)

## **Forward/Back (Skip)**





- Press  to skip forward one track (DVD, CD, MP3, etc).
- Press  to skip back one track (DVD, CD, MP3, etc).



## **Fast-Forward/Fast-Reverse (Search)**

Normal →  x2 →  x4 →  x8 →  x16 →  x32

- Press  to fast-forward through the disc. Each successive press of  will change the rate of fast-forward playback.
- Press  to fast-reverse through the disc. Each successive press of  will change the rate of fast-reverse playback.

## **Slow**

Normal →  x1/2 →  x1/4 →  x1/8 →  x1/16 →  x1/32

- Press SLOW for slow-motion playback. Each successive press of SLOW will change the rate of slow-motion playback. Press  to resume normal playback.
- Press STEP frame-by-frame playback. Each successive press of STEP will advance the video one frame. Press  to resume normal playback.

## **Note:**

*Audio will be muted during fast-forward, fast-reverse, and slow-motion playback.*

# BASIC OPERATIONS

## Menu Navigation

To navigate DVD disc menus or the player's setup menus:

- Press the DIRECTION buttons to select a desired feature or option in the menu.
- Press ENTER to confirm a selection in the menu.
  - For some menu options, you may be able to use the numeric keypad to input data.
- Press  to cancel an entry.

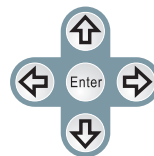

## Numeric Keypad

- Use the numeric keypad to skip directly to a DVD chapter or CD track.
- Use the numeric keypad to input numeric data in menu option fields when possible.

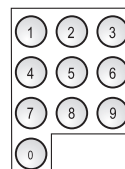

## Adjusting the Volume

- Turn the Volume Control dial to adjust the volume level up or down.
- Press MUTE to turn the volume off completely; press mute again to restore the volume to its previous level.

## Disc Error Messages

The following messages will be displayed on-screen if there is a problem with the format of the loaded disc.

- **WRONG REGIONAL DISC.** The region code of the disc does not match the player's region code (Region 1).
- **WRONG PASSWORD.** The parental rating level of the disc is higher than the parental rating level setting of the player. The player will not play the disc.
- **WRONG DISC.** The player is equipped with automatic disc quality detection software. If the player detects a disc that is damaged or has a format problem, it may play the disc at a lower quality or stop play completely, depending on how damaged the disc is.

### **Note:**

*DVD disc production quality may vary; some discs may deviate from the industry standard. Some incorrectly-formatted discs may still play, however, the playback and operational quality of the disc may be substandard.*

## Power Management

If the player will not be in use for a long period of time, set the Power Switch to the OFF position, remove the battery, and unplug the player.

# FUNCTION BUTTONS

## LCD Mode

Press the LCD MODE button to adjust the brightness, contrast, and color of the LCD screen.

1. Press the up/down DIRECTION buttons to select the desired setting to adjust. From top to bottom, the settings are: Screen, Brightness, Contrast, Color, and Reset.
2. Press the left/right DIRECTION buttons to adjust the selected setting.

- Use the SCREEN adjustment to switch between 4:3 (standard) and 16:9 (wide screen) aspect ratios.
- Use the BRIGHTNESS adjustment to make the screen brighter or darker.
- Use the CONTRAST adjustment to display a picture with higher or lower contrast.
- Use the COLOR adjustment to display a picture with higher or lower color saturation.
- Select RESET and press ENTER to return the LCD mode adjustments to their factory-default settings.

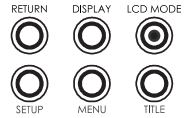
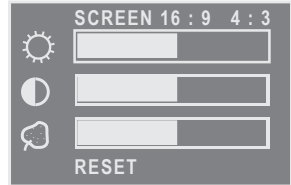

## Display

- Press the DISPLAY button once to show time information on-screen; press it twice to show status information on-screen; press it a third time to exit the on-screen display mode.
- When the player is in AV IN mode, press the DISPLAY button to toggle between TV System modes (NTSC or PAL).

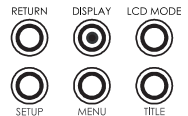

## Menu / Title / Return

- Press the MENU button during DVD playback to return to the DVD's Main menu.
- Press the TITLE button during DVD playback to return to the DVD's Title menu.
- Press the RETURN button during VCD playback to return to the disc's Root menu.

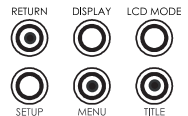

## Setup

Press the SETUP button to enter the player's setup menu. Enter the Setup menu to adjust the player's internal settings; please see the SETUP section for more details.

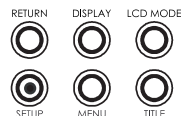



# MORE FUNCTIONS

## Search

Press SEARCH to go directly to a desired point of a disc (eg, Title, Chapter, Time).

### **DVD Chapter/Title Search:**

- Press SEARCH once to display the Chapter/Title Search Bar shown to the right.
- Press the left/right DIRECTION buttons to select (highlight) an entry field.
- Use the Numeric keypad to input the desired chapter/title number, or press the up/down DIRECTION buttons to increase/decrease the chapter/title number.
- Press ENTER to confirm and execute the search or press SEARCH to exit search mode.

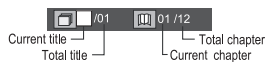

### **DVD Time Search (within a specified title):**

- Press SEARCH twice to display the Time Search Bar shown to the right.
- Use the Numeric keypad to input the desired time (hours, minutes, seconds).
  - Press CLEAR to cancel any input errors.
- Press ENTER to confirm and execute the search or press SEARCH to exit search mode.



### **CD Time Search:**

- Press SEARCH once to display the CD Time Search Bar shown to the right.
- Use the Numeric keypad to input the desired time (hours, minutes, seconds).
  - Press CLEAR to cancel any input errors.
- Press ENTER to confirm and execute the search or press SEARCH to exit search mode.



## Repeat Mode

Press REPEAT to change the repeat mode of the player. Each successive press of REPEAT will change the mode as follows:

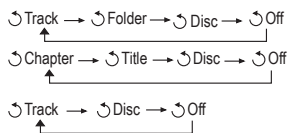

### **Note:**

*Some DVD discs do not allow Repeat mode.*

## Repeat A-B Mode

To repeat playback of a specific section of a disc (loop):

1. Press A-B to set the desired start point ("A") of the section to be repeated.
2. Press A-B again to set the desired end point ("B" of the section to be repeated.
3. The section "A-B" will now play repeatedly as a loop. Press A-B again to resume normal playback.

# MORE FUNCTIONS

## Multi-Angle/Subtitle/Audio

- During playback of a DVD that has been mastered with multiple angles, press ANGLE to view the available alternate camera angles. (A DVD may have up to 9 selectable angles.)
- During playback of a DVD that has been mastered with subtitles, press SUBTITLE to view the available subtitle tracks. (A DVD may have up to 32 selectable subtitles.)
- During playback of a DVD that has been mastered with alternate language/audio tracks, press AUDIO to hear the alternate tracks. (A DVD may have up to 8 selectable audio tracks.)

## Zoom

Press ZOOM to change the magnification level of the picture.

- During DVD playback, each successive press of ZOOM will change the level of magnification to: Zoom 2x, Zoom 4x, Normal.
- During JPEG CD playback, each successive press of ZOOM will change the level of magnification to: 25%, 50%, 100%, 150%, 200%.

When the magnification level is greater than Normal/100%, use the DIRECTION buttons to pan around the magnified picture.

**Note:** *The picture quality will decrease as the zoom level increases.*

## Program

Enter Program mode to create a custom sequence of tracks to be played.

**(Program mode is available only when the player is in NAVIGATE OFF mode. Press the PBC button to set the player to NAVIGATE OFF mode.)**

### **Note:**

*You can also use the numeric keypad to enter numbers directly in the fields. Use the direction buttons to move between entry fields.*

## **DVD Program Mode**

1. Load a DVD and press PROGRAM.
2. Press the right DIRECTION button to select the "Title" column; press the up/down DIRECTION buttons to select a title.
3. Press the right DIRECTION button to select the "Chapter" column; press the up/down DIRECTION buttons to select a chapter.
4. Press PLAY (or ENTER) to confirm the selection.
5. Repeat steps 2-4 until you have finished programming your selections or when you have programmed the maximum 20 tracks.
6. Press PLAY to start playback. Press PROGRAM to cancel.

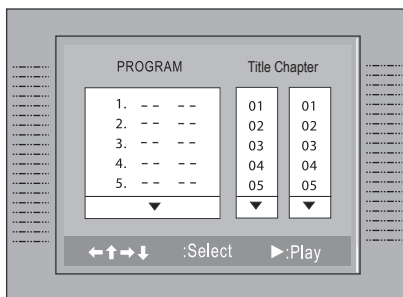

# MORE FUNCTIONS

## CD Program Mode

1. Load a CD and press PROGRAM.
2. Press the right DIRECTION button to select the "Track" column; press the up/down DIRECTION buttons to select a track.
3. Press PLAY (or ENTER) to confirm the selection.
4. Repeat steps 2-3 until you have finished programming your selections or when you have programmed the maximum 20 tracks.
5. Press PLAY to start playback. Press PROGRAM to cancel.

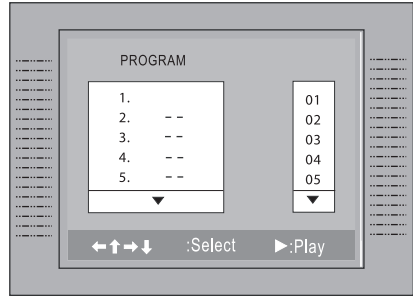

## MP3 Program Mode

1. Load an MP3-CD and press PROGRAM.
2. Use the DIRECTION buttons to select the desired file.
  - To navigate through subfolders: press the left/right DIRECTION buttons to enter/exit a folder.
3. Press the right DIRECTION button to confirm. The confirmed file will be marked as a programmed file.
4. Repeat steps 2-3 until you have finished programming your selections or when you have programmed the maximum 20 tracks.
5. Press PLAY (or ENTER) to confirm the selection.
6. Press PLAY to start playback. Press PROGRAM to cancel.

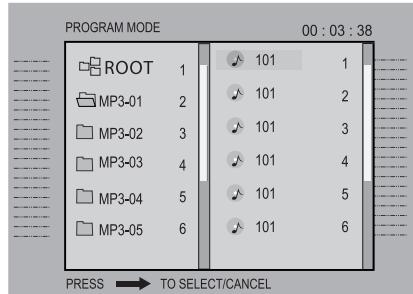

# SETUP

Enter Setup mode to adjust the various internal settings of the player. Make sure the player has been completely stopped before entering Setup mode.

1. Press **SETUP** to enter Setup mode.
2. Use the **DIRECTION** buttons to select a desired item.
3. Press **ENTER** to confirm a selection.
4. Press **SETUP** to exit Setup mode (or select **EXIT** and press **ENTER**).

## Language Setup

Use the **DIRECTION** buttons to highlight the desired language selection and press **ENTER** to confirm.

Item	Description	Options (Default is in Bold)
OSD	Sets the language of the player's on-screen display.	<b>English</b> , French, German, Italian
Menu	Sets the default menu language of loaded DVDs.	<b>English</b> , Chinese, Japanese, French, German, Italian, Spanish, Portuguese, Hindi, Thai, Russian, Korean, Others
Audio	Sets the default language audio track of loaded DVDs.	<b>English</b> , Chinese, Japanese, French, German, Italian, Spanish, Portuguese, Hindi, Thai, Russian, Korean, Others
Subtitle	Sets the default subtitle track of loaded DVDs.	<b>English</b> , Chinese, Japanese, French, German, Italian, Spanish, Portuguese, Hindi, Thai, Russian, Korean, Others

## Screen Setup

Use the **DIRECTION** buttons to highlight the desired screen selection and press **ENTER** to confirm.

Item	Description	Options (Default is in Bold)
TV Type	Sets the aspect ratio of the display. (The TF-DVD7307 screen is 16:9.)	4:3 (PS), 4:3 (LB), <b>16:9</b>
Screen Saver	The screensaver prevents burn-in damage to the player's screen.	<b>On</b> , Off
TV System	Sets the player's Video Out signal type. Set this to correspond with your TV.	<b>NTSC</b> , PAL, Auto
Brightness	Select a preset screen brightness.	<b>Normal</b> , Bright, Soft
Contrast	Adjust the screen's contrast.	-4 to +4 ( <b>0 is default</b> )

# SETUP

## Audio Setup

Use the DIRECTION buttons to highlight the desired audio selection and press ENTER to confirm.

Item	Description	Options (Default is in Bold)
Digital Out	Sets the player's Optical Out (audio) signal. For use with 5.1-channel receivers (see your receiver's manuals for more details).	<b>SPDIF/RAW</b> , SPDIF/PCM, Off

## Custom Setup

Use the DIRECTION buttons to highlight the desired Custom Setup selection and press ENTER to confirm.

Item	Description	Options (Default is in Bold)
Parental Ctrl	Sets the maturity rating level of the player. The player will not play any discs rated higher than this setting. <u>This setting is password protected (the default password is: 8888).</u>	Levels 1 to 8. ( <b>8: ADULT is default</b> )
Password	Change the Parental Ctrl password. Enter the old password, the new password, and then the new password again to verify. <b>DO NOT FORGET THE PASSWORD; this password cannot be reset.</b>	
Angle Mark	Displays an on-screen prompt whenever an alternate angle becomes available for viewing (press ANGLE to view).	<b>On</b> , Off
Default	Resets all settings to their factory-default state. <b>This will not reset the Parental Ctrl password.</b>	Read

# SPECIFICATIONS

Power Supply	AC: 100-240V UL Listed Adapter DC: 9V, 2A
Power Consumption	≤ 9.8W
Video Signal System	NTSC / PAL
Video Output	3.5mm mini-jack to RCA Composite Video
Audio Output	3.5mm Stereo Headphone 3.5mm Stereo Line-Out Optical Out
Video Input	3.5mm mini-jack to RCA Composite Video
Audio Input	3.5mm Stereo Line-In
S/N Ratio	90dB Typical
Dynamic Range (Audio)	90dB Typical
Display Type	7" TFT LCD (16:9 Wide Screen)
Display Resolution	480 x 234
Unit Dimensions	7.76" x 1.57" x 6.61" (WHD)
Weight	2.14 lbs (main unit)

# TROUBLESHOOTING

If you have a problem with this player, please read the troubleshooting guide below and check our website at [www.cobyusa.com](http://www.cobyusa.com) for Frequently Asked Questions (FAQs) and firmware updates. If these resources do not resolve the problem, please contact Technical Support.

## **COBY Electronics Technical Support**

Hours: Monday to Friday, 8:30 AM–11:00 PM EST  
Saturday to Sunday, 9:00 AM–11:00 PM EST

Email: [techsupport@cobyusa.com](mailto:techsupport@cobyusa.com)

Phone: 800-681-2629 or 718-416-3197

Web: [www.cobyusa.com](http://www.cobyusa.com)

### ***There is no power to the device.***

- Ensure that the Power Switch is physically set to the ON position.
- Ensure that the AC adapter cord is securely connected to the player and the proper wall outlet.
- Ensure that the battery pack is fully charged.

### ***The device does not play.***

- Ensure that a supported disc is loaded in the player label-side up.
- Ensure that the disc's rating level does not exceed the player's.
- Ensure that the disc is not damaged or too dirty. Clean the disc or try another disc.
- Moisture may have condensed inside the player. Remove the disc and leave the player on for 1-2 hours and then try again.

### ***There is no picture.***

- Ensure that the AV switch is set to the correct mode (AV IN or AV OUT).
- Ensure that the TV set has been powered on and is set to the correct AV mode.
- Ensure that the connections between the player and the TV are secure and correct.
- Check if the connection cables are damaged.

### ***The picture is noisy or distorted.***

- The disc may be damaged or dirty. Clean the disc or try another one.
- Reset your TV's color system.
- Ensure that the player is connected directly to the TV (and not through a VCR, cable box, satellite receiver, etc.)

### ***There is no sound or distorted sound.***

- Ensure that the TV and amplifier have been turned on and properly set up.
- Ensure that the TV and amplifier connections are secure and correct.
- Try a different Audio track of the DVD by pressing AUDIO.
- Ensure that the MUTE function of the TV, Amplifier, or Player is not engaged.

# TROUBLESHOOTING

## ***The remote control doesn't work.***

- Ensure that the Power Switch has been physically set to the ON position.
- Ensure that there are no obstacles between the remote and the player.
- Point the remote at the remote sensor on the main unit.
- Ensure that the batteries in the remote retain a charge and have been installed correctly.
- Try replacing the remote's batteries.

## ***The player has malfunctioned.***

- Unplug the player and remove the battery pack for 30 minutes. After that, reinstall the battery and plug in the player. Power on the player -- the restore function should reset the player.